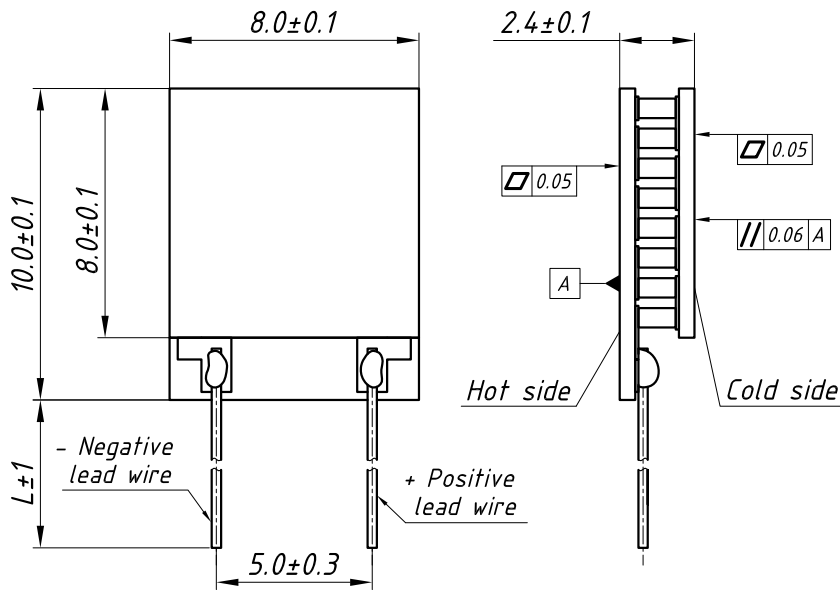

TM-32-0.6-1.5

TECHNICAL DATA

U_{max}	3.6 V	$T_{hot}=25^{\circ}\text{C}$ Vacuum
Q_{max}	3.4 W	
ΔT_{max}	72°	
I_{max}	1.5 A	
ACR at 25°C	2.2 Ohm	
Lead wires type	Cu wire Sn plated $\phi 0.3$ mm	
Solder	Lead Free, m.p.t. $\geq 227^{\circ}\text{C}$	
Hot side	Ceramics Al_2O_3 , white 96%	
Cold side		
Maximum processing temperature 180 °C		
Tolerances for thermal and electrical parameters $\pm 10\%$		
This product is compliant to RoHS (2002/95/EC)		

AVAILABLE MODIFICATIONS

Design	Description
TM-32-0.6-1.2	Porch-style design without metallization

MODIFICATIONS UPON REQUEST

Design	Description
TM-32-0.6-1.2 T	Porch-style design with metallization on the hot side
TM-32-0.6-1.2 TT	Porch-style design with metallization on both sides

STANDARD ORDERING OPTIONS

Nº	Option	Parameter
1	Lead wires length	$L \geq 30$ mm
2	Lead wires insulation	Maximum processing temperature
	Without insulation	200 °C
	Silicone (<24 AWG)	180 °C
3	PTFE (<24AWG)	200 °C
	Sealing	Maximum processing temperature
	No sealing	200 °C
	Epoxy	130 °C
	Silicone	180 °C

OPTIONS UPON REQUEST

Height tolerance	± 0.05 *
Unflatness and nonparallelism	± 0.02 *
Anticorrosion coating	

* These options are available only for module design without metallization on external sides.

For another options consult of our technical support engineers

Notes

- When applying plus voltage to positive lead wire the module cold side becomes heat absorbing surface.
- Module AC resistance at 25°C does not include resistance of lead wires.

Ferrotec Nord Corp.
 www.ferrotec-nord.com
 e-mail: info@ferrotec-nord.com
 phone: +7 (499) 357-67-71
 Peschany Carrier 3, 109383 Moscow, Russia

Performance graphs for TM-32-0.6-1.5 modules at Th=25 °C
 Environment: vacuum

